

Climate Control - Passenger Side Register

Removal and Installation

Removal



CAUTION: Do not manually open the registers. Failure to follow this instruction may result in damage to the internal components.

NOTE: If the registers are set to 'Automatic' mode and one or more are disconnected during an ignition cycle, a vehicle battery reset may be required to reconnect the affected registers to the LIN BUS.

NOTE: Removal steps in this procedure may contain installation details.

1.

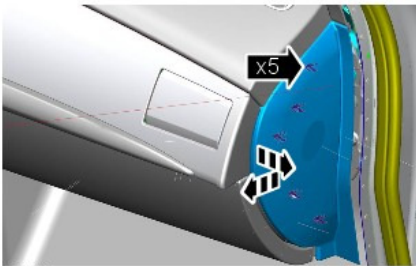
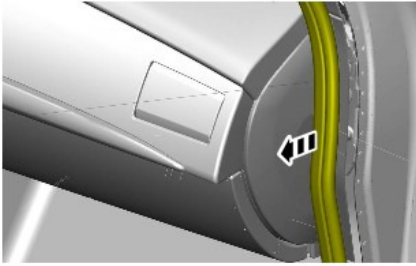

E95508

2.

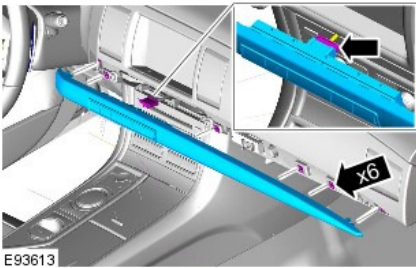

E93613

3.

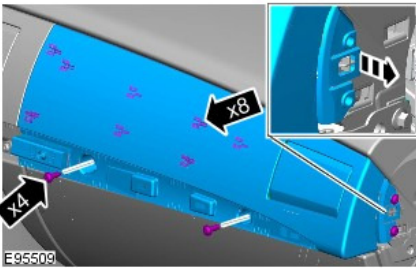

E95509

4.

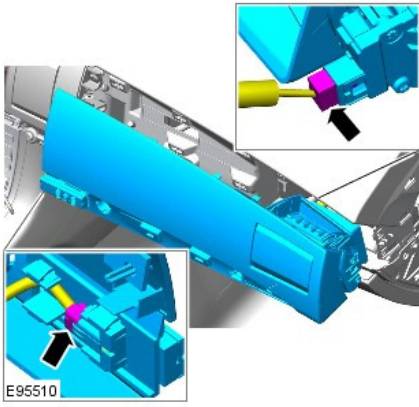

5.

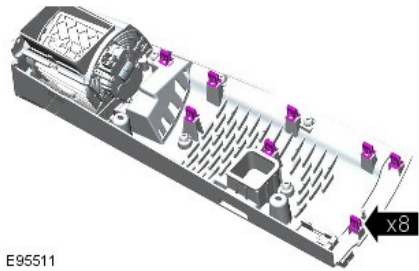

6. Install the clips into the instrument panel.

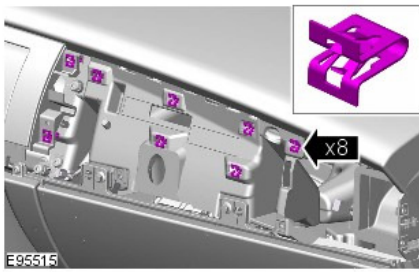

7. NOTE: Do not disassemble further if the component is removed for access only.

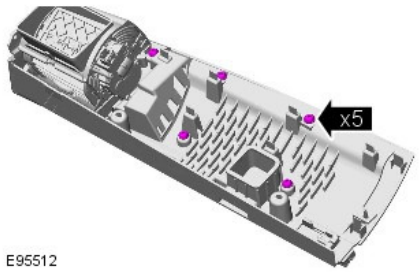

8. NOTE: When removing the component, some of the clips may remain attached. These clips should be removed and returned to their original positions in the passenger side register carrier.

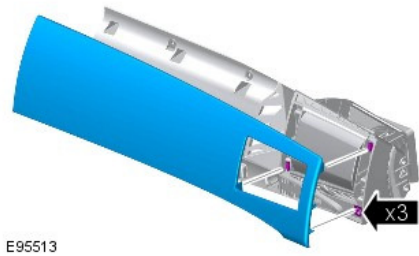

9.

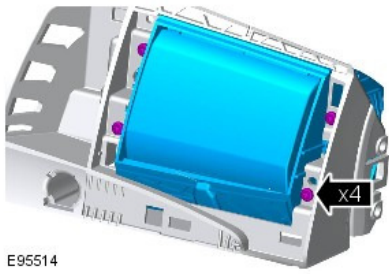

E95514

Installation

1. To install, reverse the removal procedure.